



Name	Parting Lock Set	Tapered Pin Set	Tapered Block Set (Short)	Tapered Block Set (Long)	Positioning Straight Block Set
Model	21GPLA	21TAP	21GTBS	21GTBL	21TBF
Page	115	115	116	116	117



Name	Locating Block Set	Side Straight Block Set	Locking Block Set	Compact Slide Block Sets
Model	21TN	21PL / 21PLG	21GLM	21HAS-Z50
Page	118	119	119	120



Name	Slide Block Set	Slide Block Set Oil Free™	Square Guide Bar Oil Free™	Square Guide Retainer	Square Guide Bar	Square Guide Jaws
Model	21HAS-Z46	21HAS-Z48	21HAS-Z07	21HAS-Z17	21HAS-Z18	21HAS-Z19
Page	121	122	123	123	124	124

ตารางการเลือกชิ้นส่วนตั้งตำแหน่ง | Positioning Components Selecting Chart

Shapes		Model			Page
Rounds		Parting Lock Set ชุดพาร์ทตั้งล็อก	21GPLA	Resin + Screw Set	P.115
		Tapered Pin Set ชุดเทเปอร์พิน	21TAP	-	P.115
Squares		Tapered Block Set ชุดเทเปอร์บล็อก	21GTBS	-	P.116
			21GTBL	-	P.116
		Positioning Straight Block Set ชุดสเตรทบล็อก หารตำแหน่ง	21TBF	-	P.117
		Locating Block Set ชุดบล็อก หารตำแหน่ง	21TN	Oil Groove	P.118
		Side Straight Block Set ชุดไซด์บล็อก	21PL 21PLG	-	P.119
		Locking Block Set ชุดล็อกคั่นบล็อก	21GLM	-	P.119
		Slide Block Set ชุดสไลด์บล็อก	21HAS-Z50	Oil Groove	P.120
			21HAS-Z46	Oil Groove	P.121
			21HAS-48	Oil Free™	P.122
			21HAS-Z07 21HAS-Z17	Oil Free™	P.123
	21HAS-Z18 21HAS-Z19		Oil Groove	P.124	

ชิ้นส่วนตั้งตำแหน่ง

Parting Lock Set - ชุดพาร์ทตั้งลิ้อค

Model: 21GPLA

FOIL FREE™

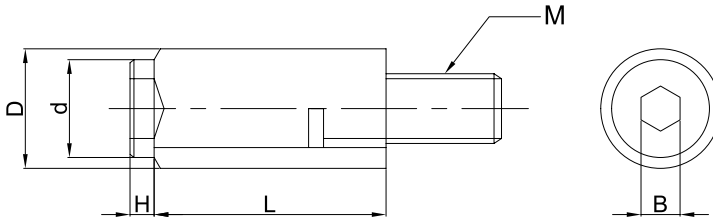

ORDER
EXAMPLE

Model D
21GPLA16



Screw : SCM435
Housing : Nylon



Max. Temp 120°C

Model	D	d	H	L	M	B
21GPLA	10	8.5	3	18	M5	4
	12	11	3.5	20	M6	5
	13	11	3.5	20	M6	5
	16	14	4	25	M8	6
	20	16	5	30	M10	8

Tapered Pin Set - ชุดเทเปอร์พิน

Model: 21TAP

FOIL FREE™

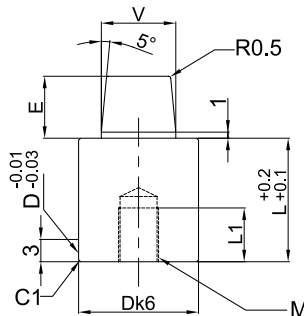
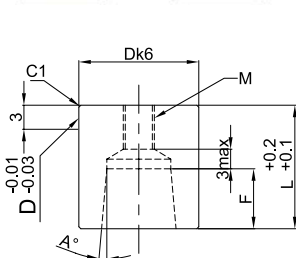

ตัวอย่างการประกอบ
Installation Example

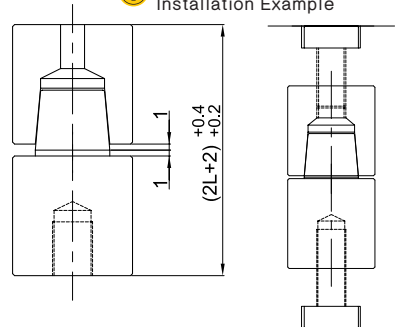

ORDER
EXAMPLE

Model D - A
21TAP20-5



SCM440 (HRC58-60)

Model	D k6	A°	L	V	E	F	M Bolt	L1
21TAP	13	5	14	8.5	6	5	M4	10
	16		14	10	6	5	M5	10
	20		19	13	9	8	M6	12
	25		24	16	12	11	M8	16
	30	29	20	15	14	M10	20	
	32	29	20	15	14	M10	20	
	35	34	24	18	17	M12	24	
	42	39	30	24	23	M12	24	

Tapered Block Set (Short) - ชุดเทเปอร์บล็อก (แบบสั้น)

Model: 21GTBS

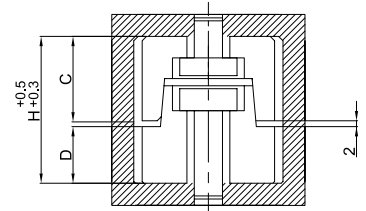
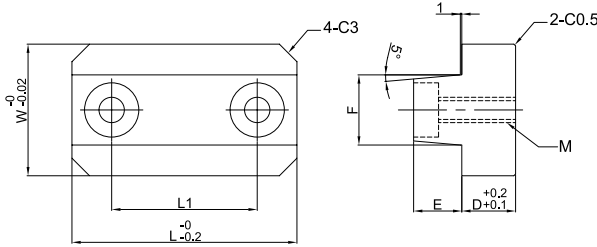

ตัวอย่างการประกอบ
Installation Example

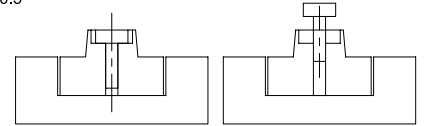
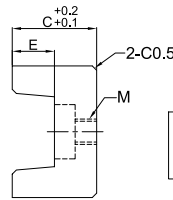
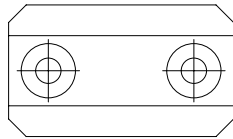

การยึดด้วยสกรู
Fixate with Bolt

การถอดด้วยขนาดสกรู
Extract with bolt

ORDER
EXAMPLE

Model W - L
21GTBS35-50

SCM440 (HRC58-60)

Model	W	L	C	D	E	F	H	Installation Bolt	M Extract Tap Hole	L1	No. Holes		
21GTBS	25	25	17	9	8	15	28	M4	M5	0	1		
		30								15	2		
		40								20	2		
	35	40	22	11	10	20	35			M6	M8	20	2
		50										30	2
		45										50	29

Tapered Block Set (Long) - ชุดเทเปอร์บล็อก (แบบยาว)

Model: 21GTBL

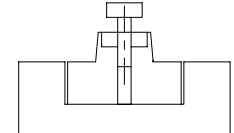
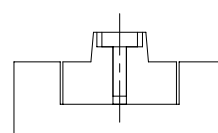
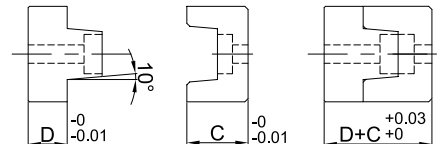
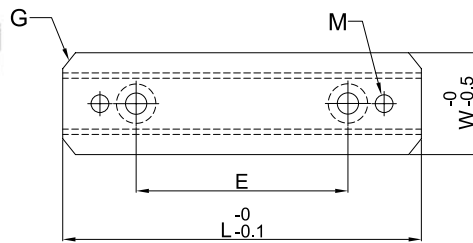

การยึดด้วยสกรู
Fixate with Bolt

การถอดด้วยขนาดสกรู
Extract with bolt

ORDER
EXAMPLE

Model L
21GTBL100

SCM440 (HRC58-60)

Model	L	W	C	D	G	Installation Bolt	No. Holes	E	M Extract Tap Hole
21GTBL	50	25	17.5	8	5	M5	1	0	M5
	100	30	22	10	5	M6	2	60	M6
	150	40	25	13	5	M8	2	100	M8

ชิ้นส่วนตั้งตำแหน่ง

Positioning Straight Block Set - ชุดสเตรทบล็อก ทาตำแหน่ง

Model: 21TBF



การติดตั้ง
Installation

! W = 16

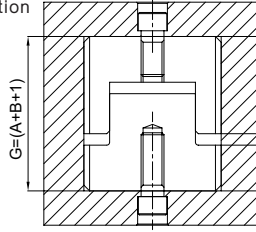

! W = 20 - 30

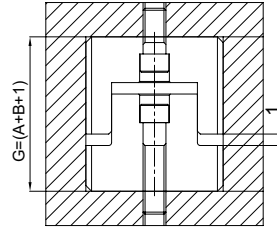

FOIL FREE™

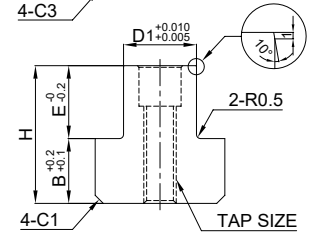
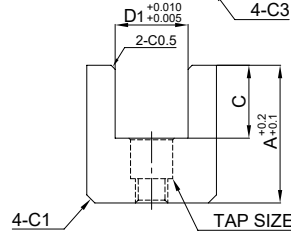
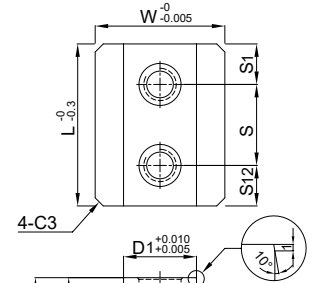
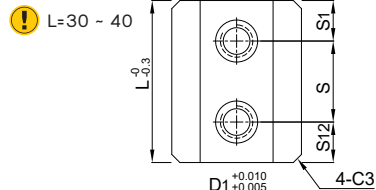
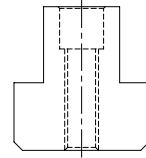
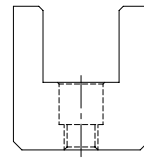
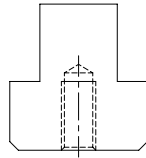
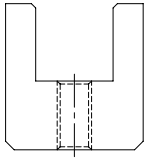
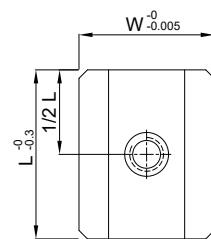
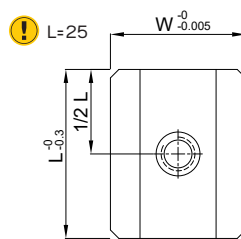
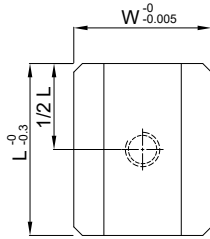
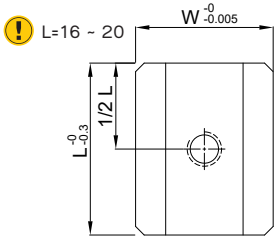

ORDER EXAMPLE Model W - L
21TBF20-25

SCM440 (HRC58-60)

Model	W	L	A	B	C	D1	D2	E	G	H	S1	S2	Installation Bolt	M Tap Hole
21TBF	16	16	17	8	9	9	9	8	26	16	-	-	M4	M4
		20												
	20	25	17	8	9	12	12	8	26	16	7.5	7.5	M3	M4
		30												
	25	25	21	10	11	15	15	10	32	20	7.5	7.5	M4	M5
		30												
	30	30	23	12	13	17	17	12	36	24	7.5	7.5	M5	M6
		40												

Locating Block Set - ชุดบล็อก ทาดำแหน่ง



Model: 21TN

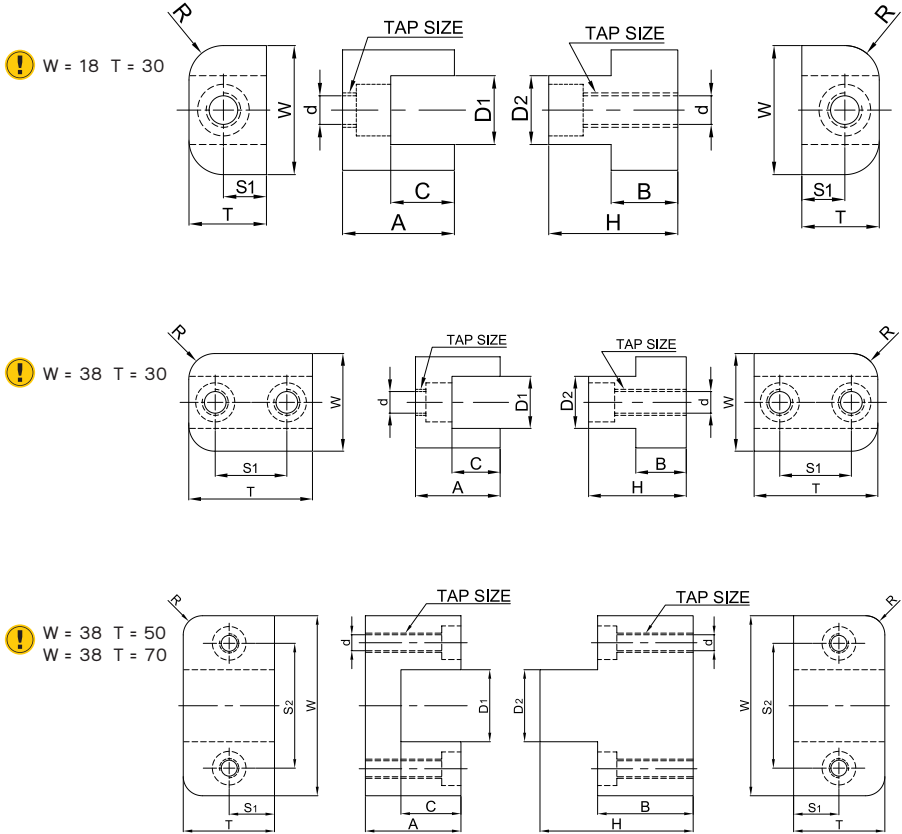

ORDER EXAMPLE Model W - T
21TN18-30

M SCM440 (HRC58-60)

Model	W	T	A	B	C	D1	D2	H	R	S1	S2	d	Installation Bolt	M Tap Hole	
21TN	18	30	26	15.5	14.8	16	16	30	9	-	10	7	M6	M8	
	38	30	26	15.5	14.8	16	16	30	9	-	22	7	M6	M8	
		50	29.8	29.8	20	20	20	20	48.8	9	35	19	7	M6	M8
		75	39.8	39.8	25	20	20	20	6.8	9	52	19	8.6	M8	M10

Positioning

ชิ้นส่วนตั้งตำแหน่ง

Side Straight Block Set - ชุดไขด์บล็อก

FOIL FREE™

Model:
21PL (Plain)
21PLG (Oil Groove)

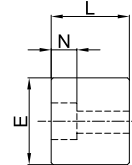
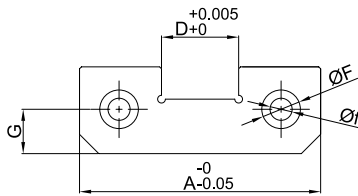
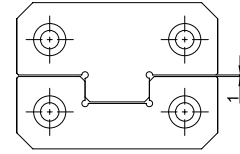
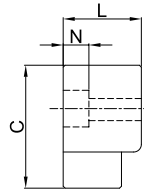
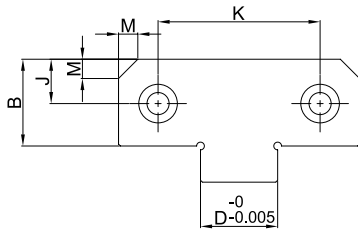

ตัวอย่างการประกอบ
Installation Example

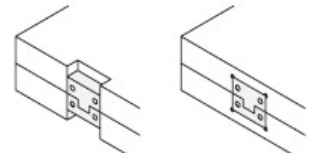

ร่องทะลุ
Groove

กัดด้วยเอ็นมิล
End Mill

ORDER Model A
EXAMPLE 21PL50 SCM440 (HRC58-60)

Model	A	B	C	D	E	F	f	G	J	K	L	M	N
21PL	38	22	30	12	22	10.5	6.5	7	7	22	13	5	8
	50	21.5	30	17	21.5	10.5	6.5	11	11	34	16	5	8
21PLG (Oil Groove)	75	36	50	25	36	16.5	10.5	18	18	50	19	8	12
	100	45	65	35	45	16.5	10.5	22	22	70	19	10	12
	125	45	65	45	45	16.5	10.5	22	22	84	25	10	12

Locking Block Set - ชุดล็อกคบล็อก

FOIL FREE™

Model: 21GLM

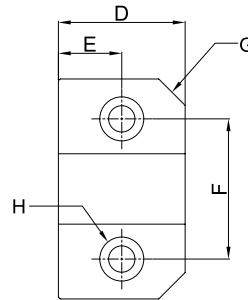
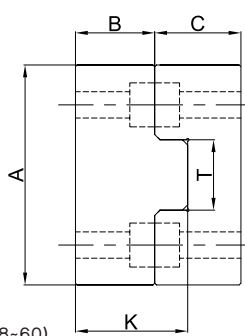

ORDER Model A
EXAMPLE 21GLM75 SCM440 (HRC58-60)

Model	A	B	C	D	E	F	G	H	K	T
21GLM	50	20	25	25	12.5	34	5	M6	30	17
	75	25	30	50	25	52	8	M8	40	30

Compact Slide Block Sets - ชุดสไลด์บล็อก แบบคอมแพ็ค



Model: 21HAS-Z50



! 21HAS-Z50-9-22

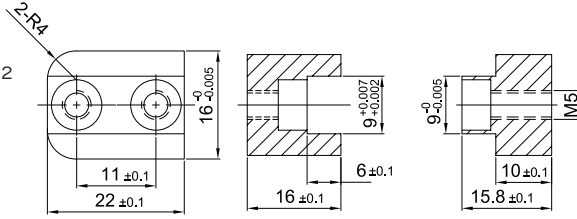

! 21HAS-Z50-16-18

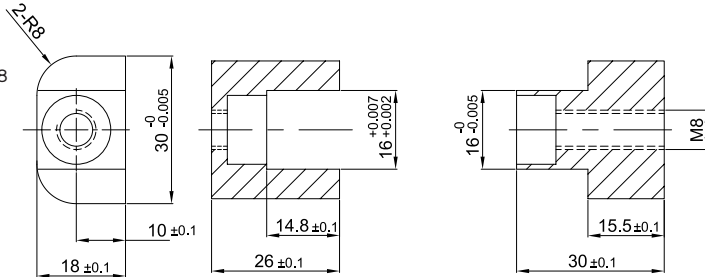

! 21HAS-Z50-16-38

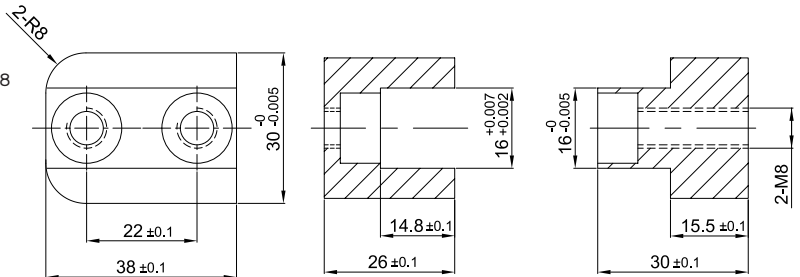

! 21HAS-Z50-20-38
21HAS-Z50-30-38

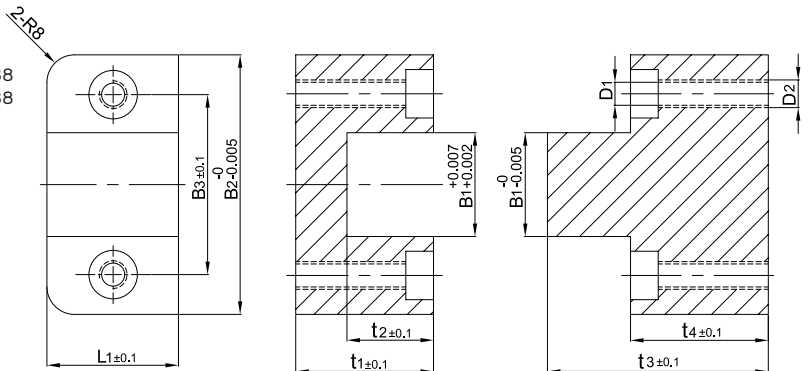

ORDER
EXAMPLE

Model - B1 - L1
21HAS-Z50-9-22



SCM440 (HRC58-60)

Model	B1	L1	B2	B3	t1	t2	t3	t4	D1	D2
21HAS-Z50	20	38	50	35	29.8	20	48.8	29.8	6.5	M8
	30	38	75	52	39.8	25	63.8	39.8	8.3	M10

ชิ้นส่วนตั้งตำแหน่ง

Slide Block Set - ชุดสไลด์บล็อก

FOIL FREE™

Model: 21HAS-Z46



ตัวอย่างการประกอบ
Installation Example

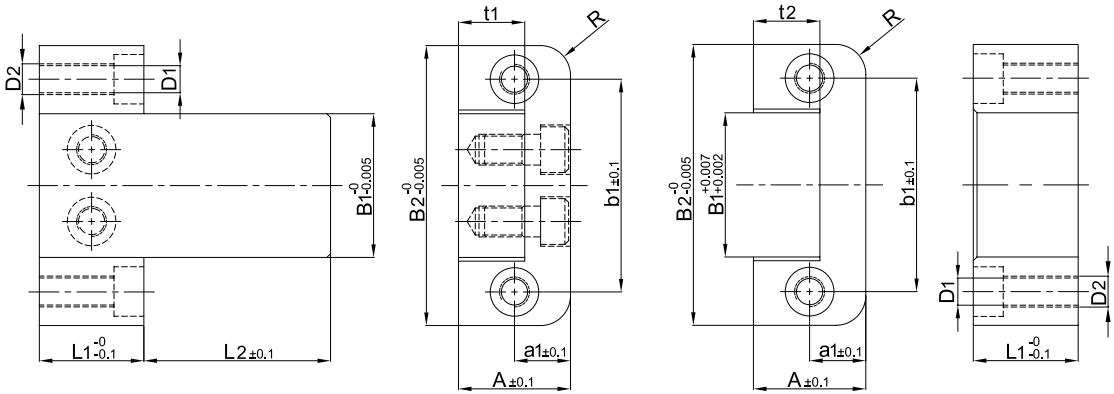
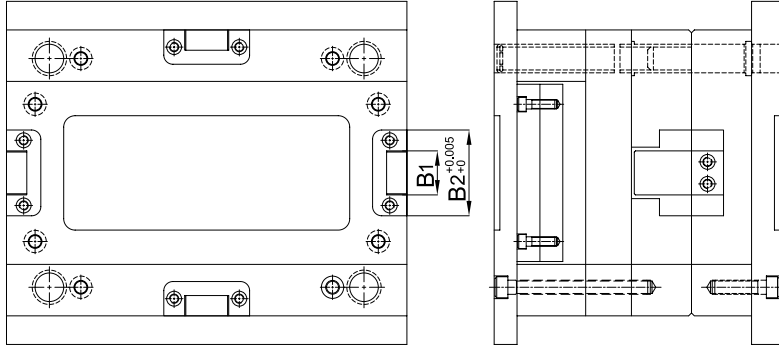

ORDER EXAMPLE Model - B1 - L1 - L2
21HAS-Z46-16-20-20

(M) SCM440 (HRC58-60)

Model	B1	L1	L2	A	B2	D1	D2	a1	b1	t1	t2	R	
21HAS-Z46	16	20	20	22	45	6.8	M8	11	30	11.5	12	8	
			40										
	30	26	40	35	60	6.8	M8	17.5	46	19.5	20	10	
			63										
	48	36	36	32	46	100	10.3	M12	23	74	25.5	26	12.5
				50									
				63									
				80									
	77	56	56	50	60	150	14	M16	30	114	35.5	36	16
				71									
				100									

Positioning

Slide Block Set Oil Free™ - ชุดสไลด์บล็อกคอยฟรี™



Model: 21HAS-Z48



ตัวอย่างการประกอบ
Installation Example

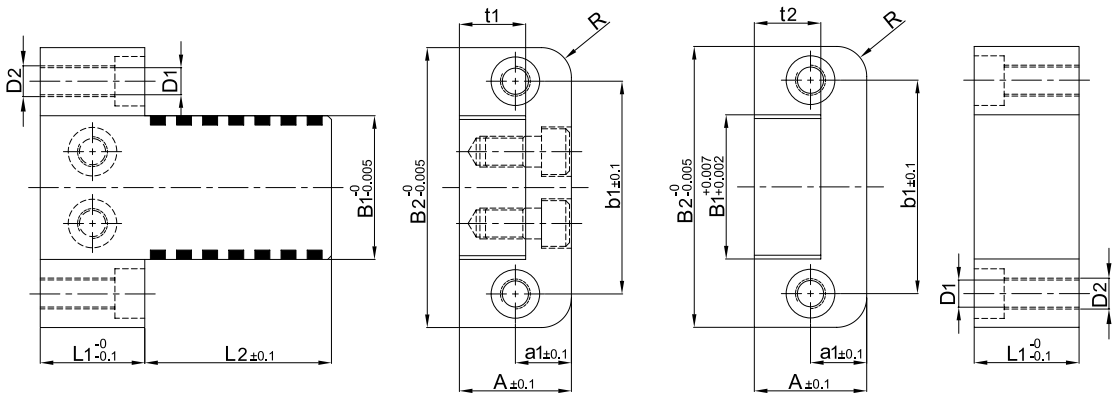
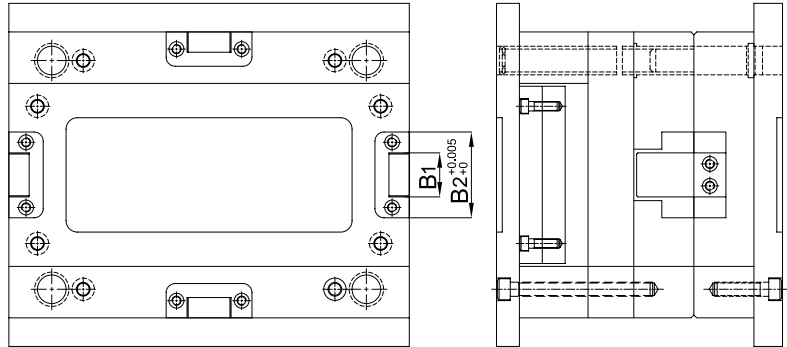

ORDER EXAMPLE Model - B1 - L1 - L2
21HAS-Z48-16-20-20

SCM440 (HRC58-60)
Oil Free™ Solid Lubricant

Model	B1	L1	L2	A	B2	D1	D2	a1	b1	t1	t2	R	
21HAS-Z48	16	20	20	22	45	6.8	M8	11	30	11.5	12	8	
			40										
	30	26	40	35	60	6.8	M8	17.5	46	19.5	20	10	
			63										
	48	36	32	46	100	10.3	M12	23	74	25.5	26	12.5	
			50										
			63										
	77	56	50	60	150	14	M16	30	114	35.5	36	16	
			71										
			100										

Positioning

ชิ้นส่วนตั้งตำแหน่ง

Square Guide Bar Oil Free™ - โกลด์บาร์ออยฟรี™

FOIL FREE™

Model: 21HAS-Z07

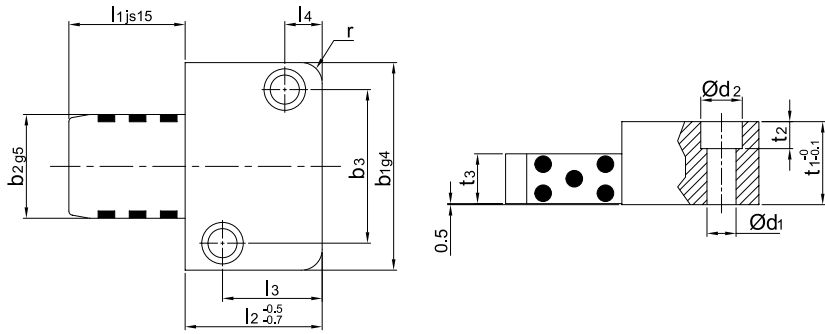

ORDER
EXAMPLE

Model - l2 - b2 - l1

21HAS-Z07-22-16-20



SCM440 (HRC58-60)
Oil Free™ Solid Lubricant

Model	l2	b2	l1	r	t3	t2	t1	d2	d1	l4	l3	b3	b1
21HAS-Z07	22	16	20	6	11	6.9	20	11	6.6	7	15	26	40
			40										
	27	20	25	6	13	6.9	22	11	6.6	7	19	31	45
			50										
	36	25	32	8	14	6.9	25	11	6.6	9	27	35	50
			63										
	46	32	40	8	19	9	32	15	9	11	35	45	63
			80										
	56	40	50	10	22	11	36	18	11	15	40	60	85
			100										
	66	50	56	10	24	13	40	20	14	18	48	74	100
			112										

Square Guide Retainer - โกลด์รีเทนเนอร์

FOIL FREE™

Model: 21HAS-Z17

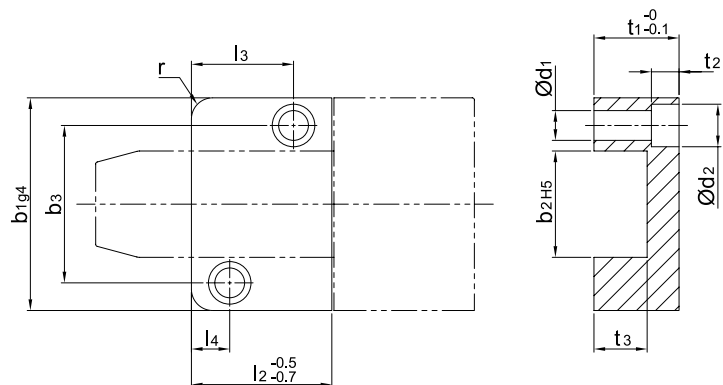

SCM440 (HRC58-60)

ORDER
EXAMPLE

Model - l2 - b2 - l1

21HAS-Z17-22-16-20

Model	l2	b2	l1	r	t3	t2	t1	d2	d1	l4	l3	b3	b1
21HAS-Z17	22	16	20	6	12	6.2	20	10.3	6.3	7	15	26	40
	27	20	25	6	14	6.2	22	10.3	6.3	7	19	31	45
	36	25	32	8	15	6.2	25	10.3	6.3	9	27	35	50
	46	32	40	8	20	9	32	15	9	11	35	45	63
	56	40	50	10	23	11	36	18	11	15	40	60	85
	66	50	56	10	25	13	40	20	14	18	48	74	100

Square Guide Bar - ไกด์บาร์

Model: 21HAS-Z18



⚠ Type 2

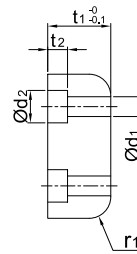
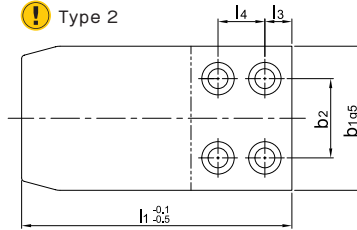

FOIL FREE™

⚠ Type 1

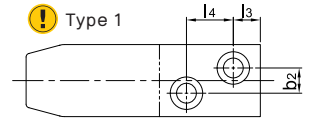

ORDER EXAMPLE Model - B - T - L
21HAS-Z18-20-18-50

Ⓜ SCM440 (HRC58-60)

Model	B	T	L	l3	l4	b2	d1	d2	t2	r1	type
21HAS-Z18	20	18	50	8	9	7	5.5	10	5.7	6	2
			75								
	32	22	70	9	18	14	6.6	11	6.8	6	
			90								
			112								
	50	30	90	12	21	24	9	15	9	8	
			125								
			150								
	63	32	112	15	26	30	11	18	11	10	
			150								
			175								
	80	35	112	15	26	44	11	18	11	12	
			150								
	100	50	175	18	32	55	13.5	20	13	15	
200											
120	65	250	20	35	75	13.5	20	13	15		
		300									

Square Guide Jaws - ไกด์จอว์ส

Model: 21HAS-Z19

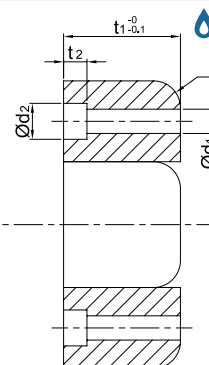
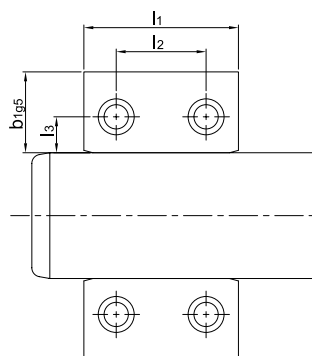

FOIL FREE™

Ⓜ SCM440 (HRC58-60)

ORDER EXAMPLE Model - B - T - L
21HAS-Z19-18-18-27

Model	B	T	L	l2	l3	d1	d2	t2	r1
21HAS-Z19	18	18	27	12	8	5.5	10	5.7	6
	20	22	36	16	10	6.6	11	6.8	6
	25	30	46	24	11	9	15	9	8
	32	32	56	30	16	11	18	11	10
	35	35	56	30	16	11	18	11	12
	40	50	76	40	17	13.5	20	13	15
	45	65	86	50	20	13.5	20	13	15

Positioning