

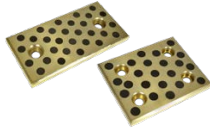

Copper Alloy Wear Plate (20mm)



Copper Alloy Wear Plate (10mm)



Copper Alloy Wear Plate (5mm)

Name	Copper Alloy Wear Plate (20mm)	Copper Alloy Wear Plate (10mm)	Copper Alloy Wear Plate (5mm)
Model	25SWW / 25SWWD	25STWW / 25STWWD	25UTWW
Page	227	228	229



Copper Alloy Wear Plate (Compact)



Cast Iron Wear Plate (20mm)



Steel Wear Plate (20mm)

Name	Copper Alloy Wear Plate (Compact)	Cast Iron Wear Plate (20mm)	Steel Wear Plate (20mm)
Model	25MSTS	25SWF / 25SWFD	25SWI
Page	230	231	232



Steel Wear Plate (10mm)



Shims for Wear Plate



Steel Slide Plate (20mm)



Slide Plate L-Shape

Name	Steel Wear Plate (10mm)	Shims for Wear Plate	Steel Slide Plate (20mm)	Slide Plate L-Shape
Model	25STWI	25SMP	25SLSPH	25SOLW
Page	233	234	235	236

 เปลี่ยนวัสดุจาก ทองเหลืองคอปเปอร์อัลลอย เป็น ซินเตอร์อัลลอยได้
Switching material from Copper Alloy to Sintered Alloy

สามารถเลือกเปลี่ยนสเปคแวร์เพลทจากวัสดุทองเหลืองคอปเปอร์อัลลอย ผัง เม็ดกราไฟต์ออยฟรี เป็น วัสดุพิเศษ ซินเตอร์อัลลอยที่มีการรวมสารหล่อลื่นออยฟรีเอาไว้แล้วบนหน้าสไลด์ได้ โปรดสอบถามฝ่ายขายของเรา
Wearplate with Copper Alloy and Oil Free solid lubricant can switch the base material to special Sintered Alloy material. For the Sintered Alloy material wearplate please ask our sale personals.

Copper Alloy Wear Plate



Sintered Alloy Wear Plate



 เพิ่มรอยบาก / ร่องน้ำมัน
Adding oil grooves

หากท่านอาจต้องการเพิ่มรอยบาก หรือ ร่องน้ำมัน บนแผ่นแวร์เพลท เราสามารถทำได้ โปรดสอบถามฝ่ายขายของเรา
We can add oil grooves to the wear plates. Please ask our sale personals for details.

Example of Oil-Grooves

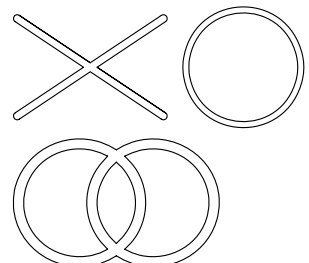

ตารางการเลือกสไลด์เพลท | Slide Plate Selection Table

Body Material	ความหนา Thickness	Model	ความกว้าง Width min - max	ความยาว Length min - max	Page
ทองเหลือง คอปเปอร์อัลลอย เกรดรับงานหนัก และ เม็ดหล่อลื่นออยฟรี™ Copper Alloy + Oil Free™ Solid Lubricant	20mm	25SWW 25SWWD 	28 - 150	75 - 350	227
	10mm	25STWW 25STWWD 	28 - 150	75 - 250	228
		25MSTS (Compact) 	15 - 22	30 - 75	230
	5mm	25UTWW 	18 - 100	50 - 150	229
	20mm 30mm 45mm	25SOLW (L-Shape) 	26 - 50	100 - 350	236
Cast Iron FC250 + Oil Free™ Solid Lubricant	20mm	25SWF 25SWFD 	28 - 200	75 - 300	231
Steel S45C + Oil Free™ Solid Lubricant	20mm	25SWI 	48 - 150	75 - 250	232
Steel SKS3 + Oil Free™ Solid Lubricant	10mm	25STWI 	28 - 125	75 - 150	233
Steel Induction Harden	20mm	25SLSPH 	28 - 150	75 - 300	235

Slide Plates

สไลด์ไวน

Copper Alloy Wear Plate (20mm) - แวร์เพลททองเหลืองคอปเปอร์อัลลอย (รุ่นหนา 20 มม)



M Copper Alloy
+ Oil Free™ Solid Lubricant

ORDER Model W - L
EXAMPLE 25SWW75-100

Model	W	L	L1	W1
25SWW	28	75	45	-
		100	50	
		150	100	
	38	75	45	-
		100	50	
		150	100	
25SWW	48	75	45	-
		100	50	
		125	75	
		150	100	
		200	150	
25SWW	58	75	45	-
		100	50	
		150	100	
25SWW	75	75	25	-
		100	50	
		125	75	
		150	100	
		200	150	
		250	200	
25SWW	100	100	50	50
		125	75	
		150	100	
		200	150	
		250	200	
		300	200	
25SWW	125	125	75	50
		150	100	
		200	150	
		250	200	
		300	200	
		350	200	
25SWW	150	150	100	100
		200	150	
		250	200	

Model: 25SWW **!** W = 28 - 75
25SWWD

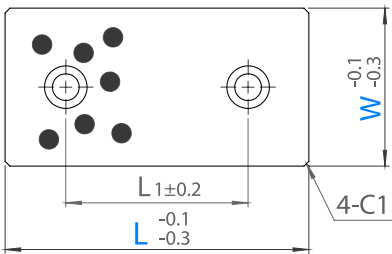

Model: 25SWW **!** W = 100 - 150

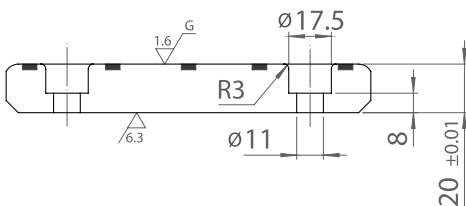
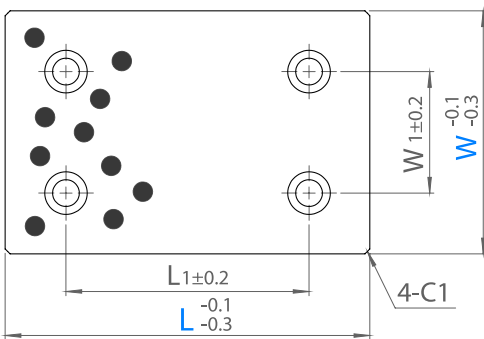

Slide Plates

Copper Alloy Wear Plate (10mm) - แวร์เพลททองเหลืองคอปเปอร์อัลลอย (รุ่นหนา 10 มม)



M Copper Alloy
+ Oil Free™ Solid Lubricant

i มีสกรูในชุด
Mounting Bolts Included

ORDER Model W - L
EXAMPLE 25STWW75-100

Model: 25STWW **!** W = 28 - 75
25STWWD

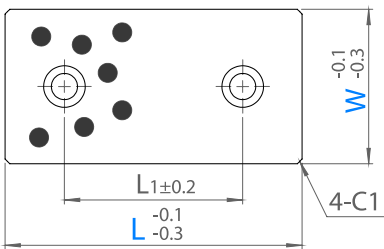

Model: 25STWW **!** W = 100 - 150

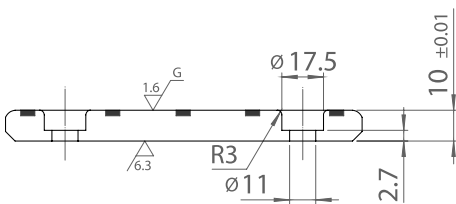
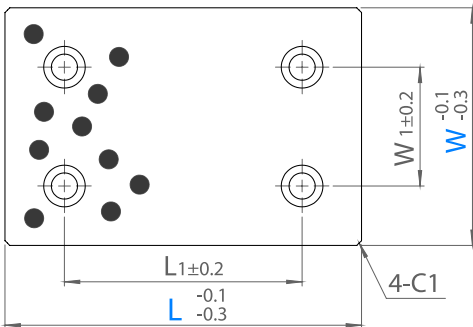

Model	W	L	L1	W1
25STWW	28	75	45	-
		100	50	
		125	75	
		150	100	
	38	75	45	-
		100	50	
		125	75	
	48	75	45	-
		100	50	
		125	75	
		150	100	
	58	75	45	-
100		50		
150		100		
75	75	25	-	
	100	50		
	125	75		
	150	100		
25STWW 25STWWD	100	100	50	50
		125	75	
		150	100	
		200	150	
	125	250	200	50
150		100		
200		150		
150	150	100	100	
	200	150		

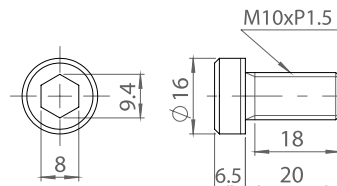

สไลด์ไวน

Copper Alloy Wear Plate (5mm) - นวาร์เพลททองเหลืองคอปเปอร์อัลลอย (รุ่นหนา 5 มม)

FOIL FREE™

Model: 25UTWW

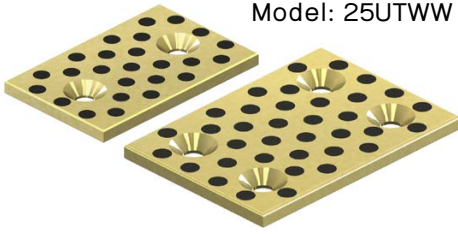

M Copper Alloy
+ Oil Free™ Solid Lubricant

i มีสกรูในชุด
Mounting Bolts Included

ORDER Model W - L
EXAMPLE 25UTWW75-100

! W = 18 - 38 L = 50 - 100
W = 48 L = 75 - 125

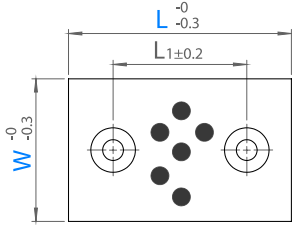

! W = 18 - 48 L = 150

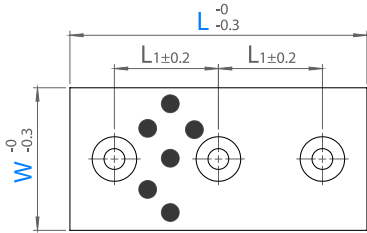

! W = 75 L = 75 - 125
W = 100 L = 100 - 125

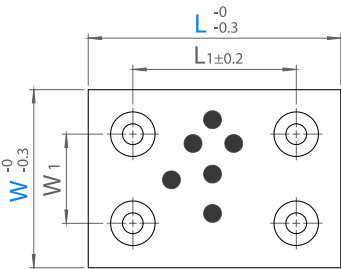

! W = 75 - 100 L = 150

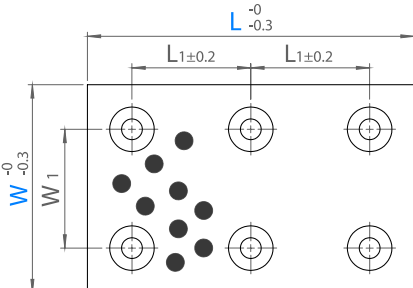

Model	W	L	L1	W1	d	h	Mounting Bolts
25UTWW	18	50	20	-	6.5	1.5	M6
		75	45				
		100	70				
		150	60				
	28	50	20	-	10	0.8	M8
		75	45				
		100	70				
	38	50	20	-	10	0.8	M8
		75	45				
		100	70				
		150	60				
	48	75	45	-	10	0.8	M8
100		70					
125		95					
150		60					
75	75	45	45	10	0.8	M8	
	100	70					
	125	95					
	150	60					
100	100	70	70	10	0.8	M8	
	125	95					
	150	60					

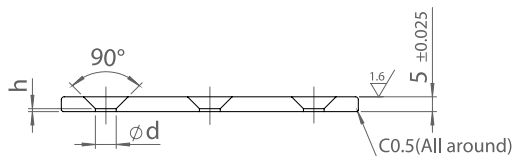

Model: 25MSTS



M Copper Alloy
+ Oil FreeTM Solid Lubricant

ORDER Model W - L
EXAMPLE 25MSTS18-50

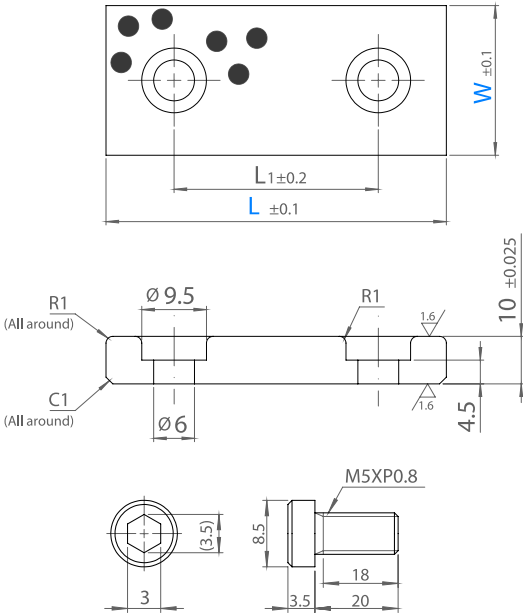

Model	W	L	L1
25MSTS	15	30	14
		40	20
		50	30
		75	50
	18	30	14
		40	20
		50	30
		75	50
	22	30	14
		40	20
		50	30
		75	50

Slide Plates

เปลี่ยนวัสดุจาก ทองเหลืองคอปเปอร์อัลลอย เป็น ซินเตอร์อัลลอยได้ Switching material from Copper Alloy to Sintered Alloy

สามารถเลือกเปลี่ยนสเปคแวร์เพลทจากวัสดุทองเหลืองคอปเปอร์อัลลอย ฝึง เม็ดกราไฟต์ออยฟรี เป็น วัสดุพิเศษ ซินเตอร์อัลลอยที่มีการรวมสารหล่อลื่นออยฟรีเอาไว้แล้วบนหน้าสไลด์ได้ โปรดสอบถามฝ่ายขายของเรา

Wearplate with Copper Alloy and Oil Free solid lubricant can switch the base material to special Sintered Alloy material. For the Sintered Alloy material wearplate please ask our sale personals.

Copper Alloy
Wear Plate



Sintered Alloy
Wear Plate



เพิ่มรอยบาก / ร่องน้ำมัน Adding oil grooves

หากท่านอาจต้องการเพิ่มรอยบาก หรือ ร่องน้ำมัน บนแผ่นแวร์เพลท เราสามารถทำได้ โปรดสอบถามฝ่ายขายของเรา

We can add oil grooves to the wear plates.
Please ask our sale personals for details.

Example of
Oil-Grooves

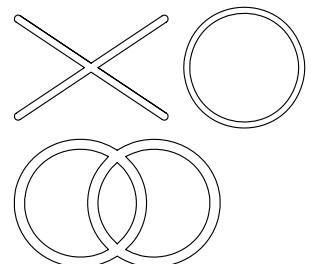

สไลด์ไวน

Cast Iron Wear Plate (20mm) - แวร์เพลทเหล็กหล่อ (รุ่นหนา 20 มม)

FOIL FREE™



ORDER Model W - L
 EXAMPLE 25SWF75-100 FC250 + Oil Free™ Solid Lubricant

Model: 25SWF W = 28 - 75
 25SWFD

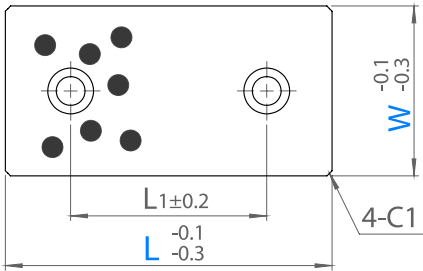

Model	W	L	L1	W1
25SWF	28	75	45	-
		100	50	
		125	75	
		150	100	
		200	150	
	38	75	45	-
		100	50	
		125	75	
		150	100	
		200	150	
	48	75	45	-
		100	50	
		125	75	
		150	100	
		200	150	
	58	75	45	-
		100	50	
		125	75	
		150	100	
		200	150	
25SWF 25SWFD	75	75	25	-
		100	50	
		125	75	
		150	100	
		200	150	
	100	250	200	50
		300	100	
		100	50	
		125	75	
		150	100	
125	200	150	50	
	250	200		
	300	200		
	150	100		
	200	150		
150	250	200	100	
	300	250		
	200	150		
	250	200		
	300	250		
25SWF	200	200	150	150
		250	200	
		300	250	

Model: 25SWF W = 100 - 150

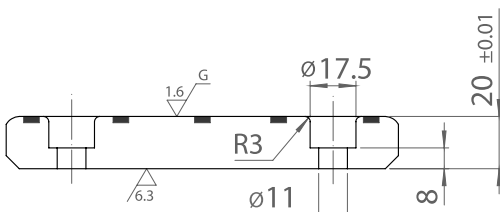
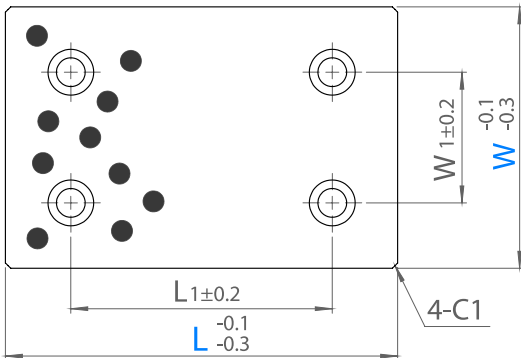

Slide Plates

Steel Wear Plate (20mm) - แวร์เพลทเหล็กกล้า (รุ่นหนา 20 มม)



Model: 25SWI



! W = 48 - 75

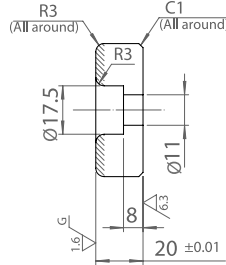
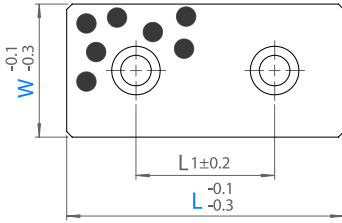

! W ≥ 100

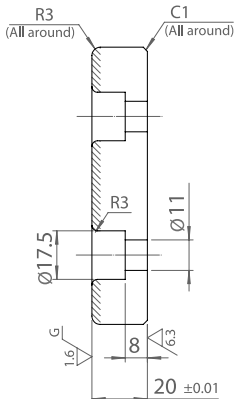
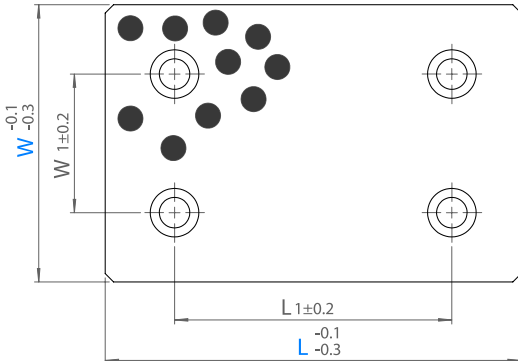

M S45C
+ Oil Free™ Solid Lubricant
45-50HRC (Induction Harden)

ORDER Model W - L
EXAMPLE 25SWI75-100

Model	W	L	L1	W1
25SWI	48	75	45	-
		100	50	
		125	75	
		150	100	
	75	75	25	-
		100	50	
		125	75	
		150	100	
	100	100	50	50
		125	75	
		150	100	
		200	150	
125	125	75	50	
	150	100		
	200	150		
	250	200		
150	150	100	100	
	200	150		
	250	200		

Slide Plates



Model: 25STWI

- SKS3 (HRC45 - 55)
+ Oil Free™ Solid Lubricant
- มีสกรูในชุด
Mounting Bolts Included

ORDER Model W - L
EXAMPLE 25STWI75-100

Model	W	L	L1	W1
25STWI	28	75	45	-
		100	50	
		125	75	
		150	100	
	38	75	45	-
		100	50	
		125	75	
		150	100	
	48	75	45	-
		100	50	
		125	75	
		150	100	
75	75	25	-	
	100	50		
	125	75		
	150	100		
100	100	50	50	
	125	75		
	150	100		
	200	150		
125	125	75	50	
	150	100		

W = 28 - 75

R2 สำหรับ W = 28 เท่านั้น
R2 only for W = 28

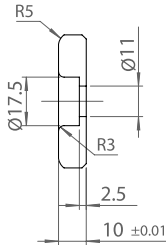
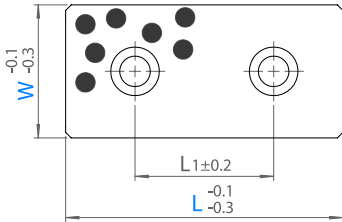

W ≥ 100

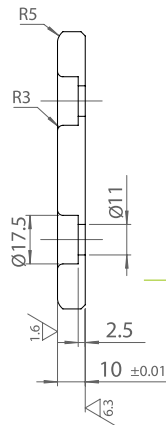
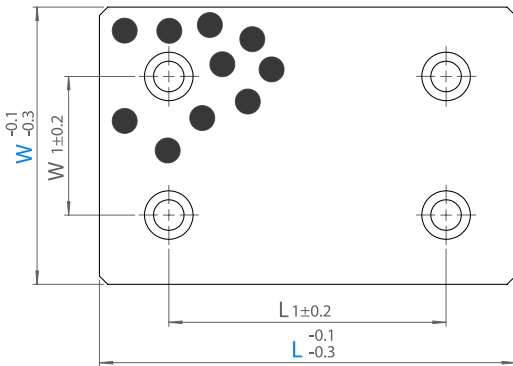

Shims for Wear Plate - แผ่นซิม สำหรับแวย์เพลท

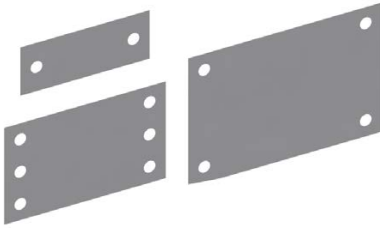

ORDER Model W - L - T
 EXAMPLE 25SMP75-100-0.10 Stainless Steel (Shim Grade)

Model: 25SMP

W = 28 - 75

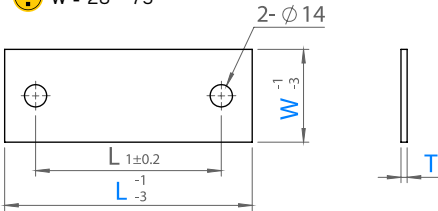

W = 100 - 150

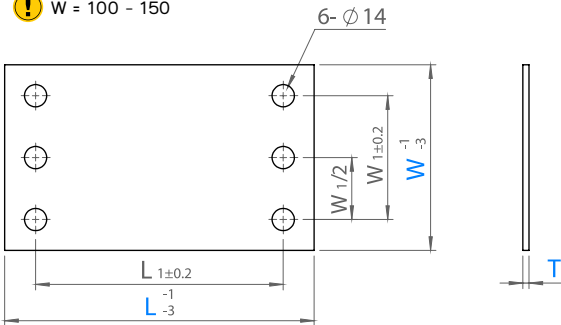

W = 200

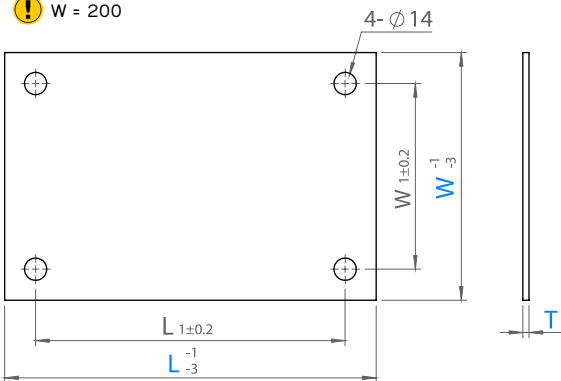

Model	W	L	T	L1	W1
25SMP	28	75	0.05 0.10 0.20 0.30 0.40 0.50 1.00 2.00	45	-
		100		50	
		125		75	
		150		100	
		200		150	
	38	75		45	-
		100		50	
		125		75	
		150		100	
		200		150	
	48	75		45	-
		100		50	
		125		75	
	58	150		100	-
		200		150	
		75		45	
	75	100		50	-
		150		100	
		200		150	
		100		50	
125		75			
150		100			
200		150			
100	100	50	50		
	125	75			
	150	100			
	200	150			
	250	200			
125	125	75	50		
	150	100			
	200	150			
	250	200			
	300	200			
150	150	100	100		
	200	150			
	250	200			
200	200	150	150		
	250	200			
	300	250			

Slide Plates

สไลด์พาน

Steel Slide Plate (20mm) - สไลด์เพลทเหล็กกล้า (รุ่นหนา 20 มม)



Model: 25SLSPH



M S45C (HRC55 or more)

58-62HRC (Induction Harden)

ORDER Model W - L
EXAMPLE 25SLSPH75-100

! W = 28 - 75

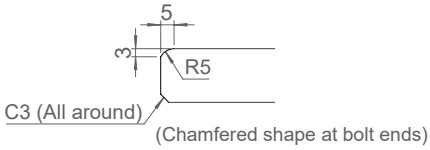
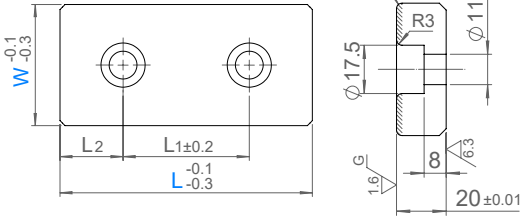

! W ≥ 100

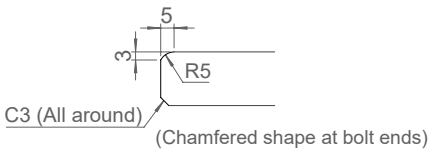
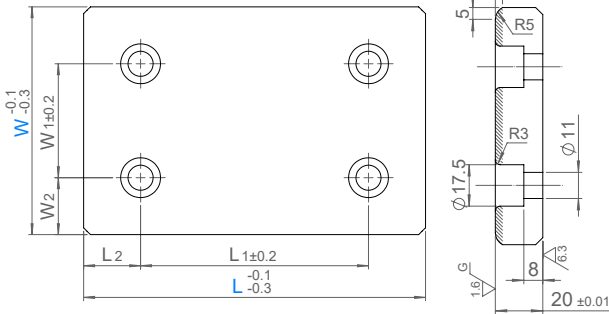

Model	W	L	W1	W2	L1	L2
25SLSPH	28	75			45	15
		100	-	-	50	25
		150			100	
	38	75			45	15
		100	-	-	50	25
		150			100	
	48	75			45	25
		100			50	
		125	-	-	75	
		150			100	
		200			150	
	58	75			45	25
100		-	-	50		
150				100		
75	75			45	25	
	100			50		
	125	-	-	75		
	150			100		
	200			150		
100	100			50	25	
	125			75		
	150	50	25	100		
	200			150		
	250			200		
125	125			75	25	
	150			100		
	200	50	37.5	150		
	250			200		
	300			200		
150	150			100	25	
	200	100	25	150		
	250			200		

Slide Plates

Slide Plate L-Shape - สไลด์เพลทตัวแอล

Model: 25SOLW

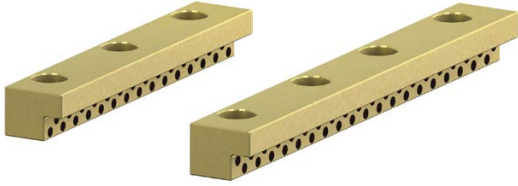

! แบบตามด้านยาว (L)
Drawing for each length (L)

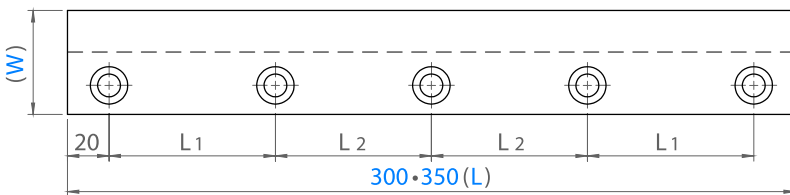
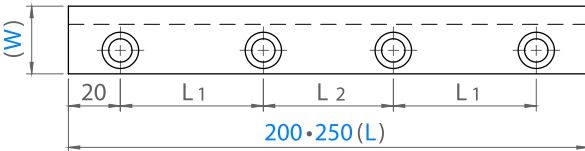
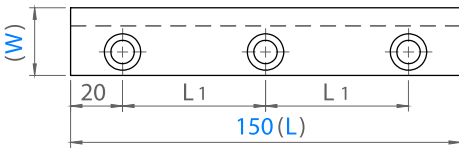
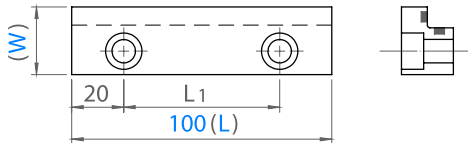

! แบบตามด้านกว้าง (W)
Drawing for each width (W)

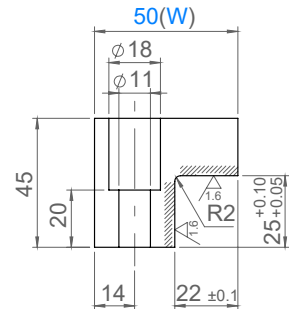
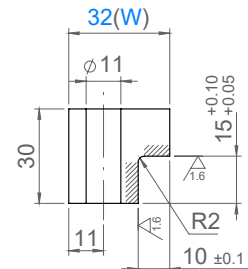
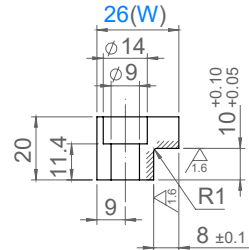

ORDER EXAMPLE Model W - L Copper Alloy + Oil Free™ Solid Lubricant

25SOLW32-100

Model	W	L	L1	L2	Mounting Bolts		
					Size	No.	
25SOLW	26	100	60	-	M8	2	
		150	55	-		3	
		200	-	50		4	
	32	100	60	-	M10	2	
		150	55	-		3	
		200	55	50		4	
	50	250	70	70	M10	4	
		200	55	50		5	
		250	70	70			
		300	65	65			
			350	80	75		