

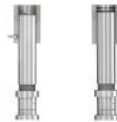

Name	Steel Die Set (SB)	Steel Die Set (SC)	Steel Die Set (SD)	Steel Die Set (SF)
Model	25SB	25SC	25SD	25SF
Page	31	33	35	37



Name	Press-Fit Ball Guide Post for Die Set	Removable Ball Guide Post for Die Set
Model	25PB / 25PM / 25PK / 25GB / 25GM / 25GK	25RB / 25RM / 25RK / 25QB / 25QM / 25QK
Page	39	40



Name	Press-Fit Guide Post for Die Set	Removable Guide Post for Die Set
Model	25PD / 25PZ	25RD / 25RZ
Page	41	42

สูตรคำนวณค่า FL สำหรับไกด์โพสบล็อกลูกปืน
Calculation Guide for Ball Guide Post 'FL'

⚠ สำหรับเสาคัดแบบมีสต็อปเปอร์ ค่า FL ควรมีค่าเท่ากับ 1.1 ถึง 1.2 เท่าของค่าที่ได้จากการคำนวณ
For guide with stoppers. FL should be 1.1 to 1.2 times the result of calculation.

📌 แบบสวมอัด
Press-Fit Type

$$FL = L - (T_1 + R + (RL/2))$$

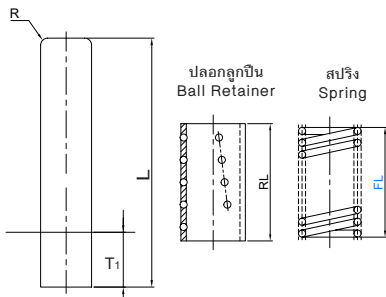

T₁ = ความหนของที่ยึดตาย
Height of die fitting

📌 แบบถอดได้
Removable Type

$$FL = L - (T + R + (RL/2))$$

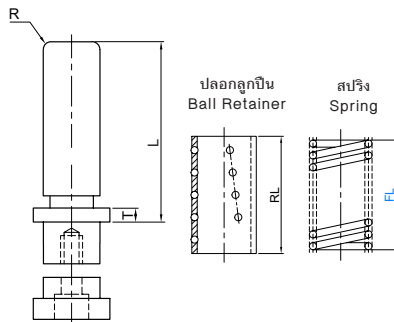

ตารางการเลือกไดเซต | Die Sets selecting chart

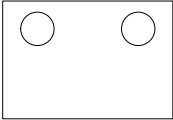
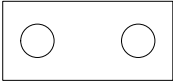
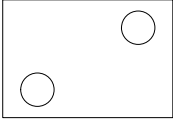
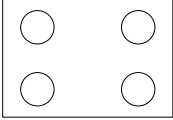
Type	No. Guides	Page
25SB 	2	P 31
25SC 	2	P 33
25SD 	2	P 35
25SF 	4	P 37

i ขั้นตอนการเลือกไดเซต
Steps in choosing Die Sets

1. เลือกประเภทของไดเซตที่ต้องการ ซึ่งจะแตกต่างกันในตำแหน่งการวางเสา และจำนวนเสาของไดเซต (ตารางซ้ายมือ)
2. เลือกขนาดของไดเซตตามพื้นที่การใช้งานที่ต้องการ (a x b)
3. เลือกประเภทของเสาไกด์ที่ต้องการว่าต้องการแบบยึดตายหรือแบบถอดเปลี่ยนได้ (ตารางด้านล่าง)
4. เลือกประเภทบุช และปลอกลูกปืนหากเลือกบุชลูกปืน (ตารางด้านล่าง)
5. เลือกความสูง L (ชั้นลงทีละ 10 มม.) ซึ่งจะถูกกำหนดตามขนาดของค่าขนาดเสา d ในตารางสเปคสินค้า
6. เลือกความยาวบุช L1 ซึ่งมีผลต่อความสูงของไดเซตตอนปิด

1. Choose die set type (left table) they are different in guide position and number of guides.
2. Choose die set size from working area (a x b)
3. Choose guide type (lower table)
4. Choose bush and ball retainer types (lower tables)
5. Choose height 'L' (10mm increment) which is limited by guide diameter 'd' in the spec table.
6. Choose bush length 'L1'

เสาไกด์ และ บุช | Guide and Bush

ประเภทของไกด์ Guide Type	Code	ประเภทของบุช Bush Type	Code
เสายึดตาย Fixed Guide	FG	บุชเหล็ก Steel Bush	SB
		บุชออยฟรี Oil Free Bush	OB
เสาถอดได้ Detachable Guide	DG	บุชลูกปืน ไม่มีฝาครอบ Ball Retainer No Stopper	NB
		บุชลูกปืน ฝาครอบเลื่อนได้ Ball Retainer Movable Stopper	MB
		บุชลูกปืน ฝาครอบตายตัว Ball Retainer Fixed Stopper	FB

ปลอกลูกปืน | Ball Retainers

Ball Retainer Type	Usage	Code	Ball Retainer Type	Usage	Code
อลูมิเนียม Aluminum	 แข็งแรง เหมาะกับการใช้งานโดยทั่วไป Strong, good for most usage	BA	เรซิน Resin	 น้ำหนักเบา เหมาะกับการงานพรีซิชั่น Lighter, good for precision die	BS

Die Sets

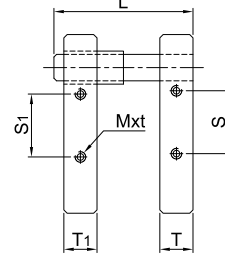
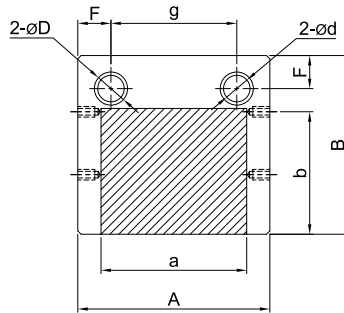

Model: 25SB

ORDER Model a - b - Guide - Bush - (Ball Retainer) - d - L - L1
 EXAMPLE 25SB200-125-DG-OB-25-150-60

ดูตารางเพิ่มเติมในหน้าต่อไป
 See addition table in the next page

Model	a	b	Guide	Bush	(Ball Retainer) Type	d	A	B	F	g	T1	T	M x t	S	S1												
25SB	100	100				22	140	160	30	80	30	35	-	-													
	125						160			100																	
	160						200			130																	
	180						220			150																	
	200						250			180																	
	230						280			210																	
	250						300			230																	
	300						350			280																	
	125						125											28	160	200	35	90	35	40	M10 x 20	135	
	160																		200			130					
	180	220	150																								
	200	250	180																								
	230	280	210																								
	250	300	230																								
	300	350	280																								
	350	SB (steel)	FG (fixed)	NB (no cap ball)	BA (Aluminum)	28		420	210		40	340	40	50					175			-					
	400							480				400															
	160							200				130															
	180						220	150																			
	200						250	180																			
	230						280	210																			
	250						300	230																			
	300						MB (movable ball)	DG (detachable)		FB (fixed ball)		BS (Resin)				38	350	240		40	270		40	50	M12 x 25	90	70
	350																420				340						
	400																480				400						
	450	550	470																								
	180	180				28			220		250		35	150	35		40		M12 x 25		110	110					
	200								250					180													
	230								280					210													
	250								300					220													
300	350								270																		
350	420								340																		
400	480						400																				
200	200									38		250		280		40		170		40			50	M12 x 25	120	120	
250												300						220									
300												350						270									
350		420	340																								
400		480	400																								
450		550	450																								
500		600	500																								
		45				45					300	50	450		45		60		100		100						
											600		500														

Model	a	b	Guide	Bush	(Ball Retainer) Type	d	A	B	F	g	T1	T	M x t	S	S1										
25SB	230	230	FG (fixed)	SB (steel)	BA (Aluminum)	38	280	310	40	200	40	50	M12 x 25	140	140										
	250						220																		
	300						270																		
	350						340																		
	400						380																		
	250	250				45	300	350	50	220	45	60		M12 x 25	150	150									
	300						270																		
	350						340																		
	400						380																		
	450						450																		
	500	300				50	600	400	50	500	45	60	M12 x 25		200	200									
	550						550																		
	300						300			50							350	400	50	250	45	60	M16 x 30	190	190
	350																320								
	400																380								
	450	450																							
	500	500																							
	550	350				50	650	450	50	540	50	60	M12 x 25	250	250										
	350						320																		
	400						380																		
450	450																								
500	500																								
550	350	50	650	460	55	540	50	60	M16 x 30	220	220														
350			320																						
400			380																						
450			450																						
500			500																						

Die Sets

บุชเหล็ก
Steel Bush

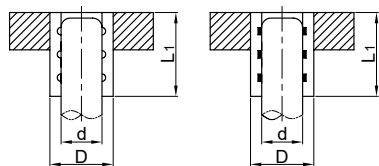

SB

OB

บุชปลอกลูกปืน
Ball Retainer Bush

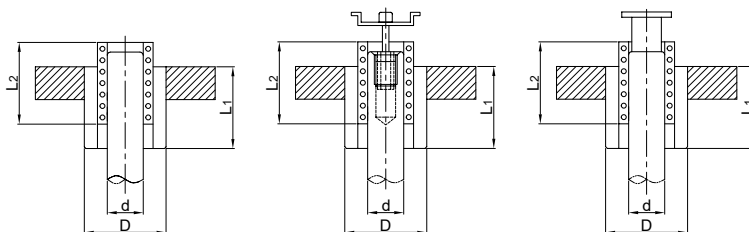

NB

MB

FB

ORDER EXAMPLE Model a - b - Guide - Bush - (Ball Retainer) - d - L - L1
25SB200-125-DG-OB-25-150-60

! เลือกค่าความยาวเสา L และ ความสูงบุช L1
Choose overall guide length L and bush height L1

d	L (10mm increment)	For Steel Bush (SB, OB)		For Ball Retainer Bush (NB, MB, FB)		
		D	L1	D	L1	L2
22	120 - 180	34	50	40	50	50
			60		60	60
28	140 - 200	42	60	50	60	60
			80		80	75
38	180 - 260	54	80	64	80	75
			100		100	90
45	180 - 260	62	100	74	100	90
			120		120	110
50	200 - 260	70	100	83	100	90
			120		120	110

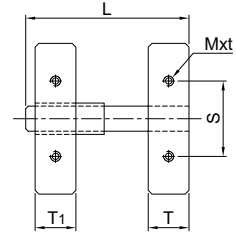
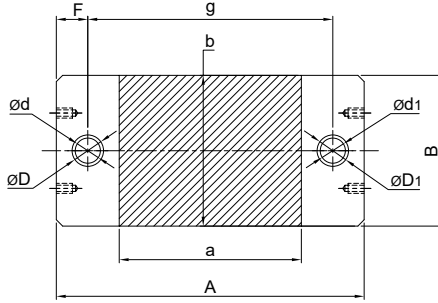

Model: 25SC

ORDER Model a - b - Guide - Bush - (Ball Retainer) - d - L - L1
EXAMPLE 25SC200-125-DG-OB-25-150-60

! ดูตารางเพิ่มเติมในหน้าต่อไป
 See addition table in the next page

a	b	Guide	Bush	(Ball Retainer) Type	d	d1	A	B	F	g	T1	T	M x t	S									
100	100				20	22	210	100	30	150	30	35	-	-									
125							230		30	170													
160							280		35	210													
180					25	28	300		35	230	35	40			M12 x 25	70							
200							320		35	250													
230							350		35	280													
250							380		35	310													
300							420		35	350													
125					125					25	28	250			125	35	180	35	40	-	-		
160	280	35	210																				
180	300	35	230																				
200	320	35	250																				
230	350	35	280																				
250	380	35	310																				
300	420	35	350																				
350		SB (steel)	500	40				420				40	50										
400			550	40				470															
160	160	FG (fixed)	OB (oilfree)	BA (Aluminum)	25	28	280	160	35	210	35	40	M12 x 25	90									
180							300		35	230													
200							320		35	250													
230							350		35	280													
250							380		35	310													
300							450		40	370													
350							500		40	420													
400							550		40	470													
450							600		40	520													
180	180	DG (detachable)	NB (no cap ball)	BS (Resin)	25	28	300	180	35	230	35	40	M12 x 25	110									
200							320		35	250													
230							350		35	280													
250					32	38	400		40	320	40	50			M12 x 25	120							
300							450		40	370													
350							500		40	420													
400					550	40	470																
200					200					32	38	350					200	40	270	40	50	M12 x 25	120
250												400						40	320				
300	450	40	370																				
350	500	40	420																				
400	550	40	470																				
450	38	45	650	50				550		45	60												
500			700	50				600															

a	b	Guide	Bush	(Ball Retainer) Type	d	d1	A	B	F	g	T1	T	M x t	S					
230	230	FG (fixed)	SB (steel)	BA (Aluminum)	32	38	380	230	40	300	40	50	M12 x 25	130					
250							400		40	320									
300							450		40	370									
350							500		40	420									
400							600		50	500									
250	250				FG (fixed)	SB (steel)	BA (Aluminum)	32	38	400	250	40			320	40	50	M12 x 25	150
300										450		40			370				
350										500		40			420				
400										600		50			500				
450										650		50			550				
500	700	50	600																
550	750	50	650																
300	300	DG (detachable)	NB (no cap ball)	BS (Resin)				38	45	500	300	50	400	45	60	M12 x 25	180		
350										550		50	450						
400										600		50	500						
450					650	50	550												
500					700	50	600												
550	750				55	640													
350	350				DG (detachable)	MB (movable ball)	BS (Resin)	45	50	550	350	50	450	45	60			M16 x 30	210
400										600		50	500						
450										650		50	550						
500										700		55	590						
550		750	55	640															

Die Sets

บุชเหล็ก
Steel Bush

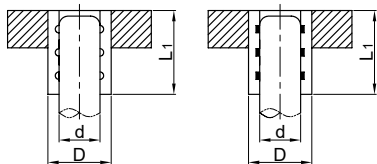

SB

OB

บุชปลอกลูกปืน
Ball Retainer Bush

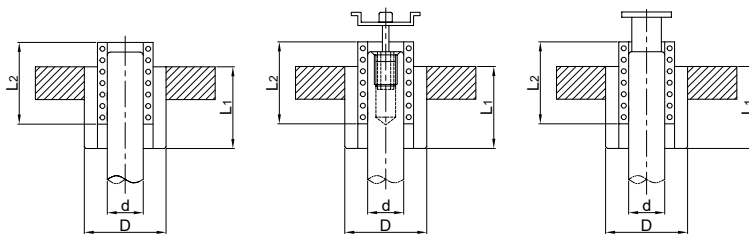

NB

MB

FB

ORDER EXAMPLE Model a - b - Guide - Bush - (Ball Retainer) - d - L - L1
25SC200-125-DG-OB-25-150-60

! เลือกค่าความยาวเสา L และ ความสูงบุช L1
Choose overall guide length L and bush height L1

d	d1	L (10mm increment)	For Steel Bush (SB, OB)			For Ball Retainer Bush (NB, MB, FB)			
			D	D1	L1	DR	DR1	L1	L2
20	22	120 - 180	31	34	50	37	40	50	50
					60				
25	28	140 - 180	37	42	80	45	50	60	60
					80			80	75
32	38	180 - 240	46	54	80	55	64	80	75
					100			100	90
38	45	180 - 260	54	62	100	64	74	100	90
					100			100	90
45	50	200 - 260	62	70	100	74	83	100	90
					120			120	110

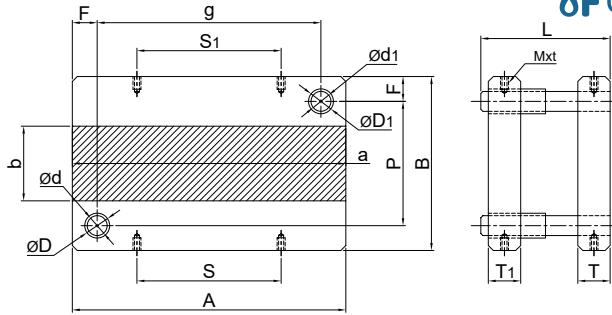
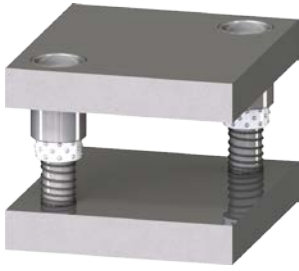

Model: 25SD

ORDER Model a - b - Guide - Bush - (Ball Retainer) - d - L - L1
EXAMPLE 25SD200-125-DG-OB-25-150-60

! ดูตารางเพิ่มเติมในหน้าต่อไป
 See addition table in the next page

a	b	Guide	Bush	(Ball Retainer) Type	d	d1	A	B	F	g	P	T1	T	M x t	S	S1
100	100				20	22	100	210	30	40	150	30	35	-	-	
125							125									
160							160									
180							180									
200					200	220	35	25	28	200						
230					230											
250					250											
300					300											
125	125				25	28	125	250	35	180	35	40	-	-		
160							160									
180							180									
200							200									
230							230									
250							250									
300							300									
350							350									
400	400															
160	160	FG (fixed)	SB (steel)	BA (Aluminum)	25	28	160	280	35	210	35	40	M10 x 20	135	-	
180							180									
200							200									
230							230									
250					250											
300					300											
350					350											
400					400											
160	160	DG (detachable)	NB (no cap ball)	BS (Resin)	25	28	200	310	40	230	40	50	M12 x 25	140	140	
180							180									
200							200									
230							230									
250					250											
300					300											
350					350											
400					400											
450	450															
180	180				25	28	180	310	35	240	35	40	M10 x 20	155	-	
200							200									
230							230									
250							250									
300					300											
350					350											
400					400											
450					450											
200	200				32	38	200	330	40	250	40	50	M12 x 25	140	140	
250							250									
300							300									
350							350									
400					400											
450					450											
500					500											
200					200				32	38	250	350	40	270	270	40
250	250															
300	300															
350	350															
400	400															
450	450															
500	500															
200	200								38	45	250	380	50	280	45	60
250					250											
300					300											
350					350											
400					400											
450					450											
500					500											

Die Sets

a	b	Guide	Bush	(Ball Retainer) Type	d	d1	A	B	F	g	P	T1	T	M x t	S	S1			
230	230	FG (fixed) DG (detachable)	SB (steel) OB (oilfree) NB (no cap ball) MB (movable ball) FB (fixed ball)	BA (Aluminum) BS (Resin)	32	38	230	380	40	150	300	40	50	M12 x 25	90	70			
250							170			90					90				
300							220			140					140				
350							270			190					190				
400							300			200					200				
250	250				FG (fixed) DG (detachable)	SB (steel) OB (oilfree) NB (no cap ball) MB (movable ball) FB (fixed ball)	BA (Aluminum) BS (Resin)	32	38	250	400	40	170	320	40	50	M12 x 25	90	90
300										220			140					140	
350										270			190					190	
400										300			200					200	
450										350			250					250	
500	300	FG (fixed) DG (detachable)	SB (steel) OB (oilfree) NB (no cap ball) MB (movable ball) FB (fixed ball)	BA (Aluminum) BS (Resin)				38	45	400	450	50	300	350	45	60	M12 x 25	200	200
450										350			250					250	
500										400			300					300	
550										450			350					350	
300										500			400					400	
350	300				FG (fixed) DG (detachable)	SB (steel) OB (oilfree) NB (no cap ball) MB (movable ball) FB (fixed ball)	BA (Aluminum) BS (Resin)	38	45	300	480	50	200	380	45	60	M12 x 25	100	100
350										250			150					150	
400										300			200					200	
450										350			250					250	
500										400			300					300	
550	350	FG (fixed) DG (detachable)	SB (steel) OB (oilfree) NB (no cap ball) MB (movable ball) FB (fixed ball)	BA (Aluminum) BS (Resin)				45	50	550	500	55	440	390	50	60	M16 x 30	320	320
350										350			150					150	
400										400			200					200	
450										450			250					250	
500										500			300					300	
550	350				FG (fixed) DG (detachable)	SB (steel) OB (oilfree) NB (no cap ball) MB (movable ball) FB (fixed ball)	BA (Aluminum) BS (Resin)	38	45	350	550	50	250	450	45	60	M12 x 25	150	150
400										300			200					200	
450										350			250					250	
500										400			300					300	
550										450			350					350	
500	350	FG (fixed) DG (detachable)	SB (steel) OB (oilfree) NB (no cap ball) MB (movable ball) FB (fixed ball)	BA (Aluminum) BS (Resin)				45	50	500	550	55	390	440	50	60	M16 x 30	270	270
550										440			320					320	

Die Sets

บุชเหล็ก
Steel Bush

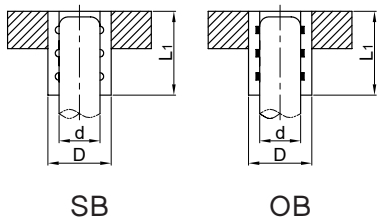

บุชปลอกลูกปืน
Ball Retainer Bush

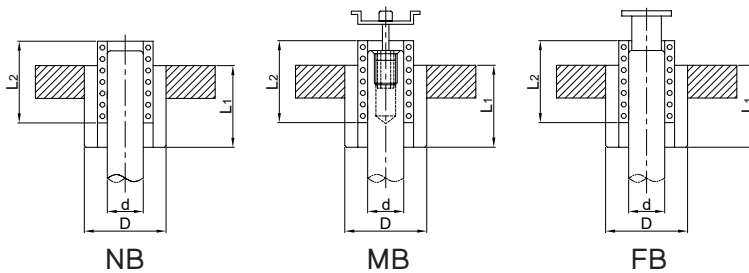

ORDER EXAMPLE Model a - b - Guide - Bush - (Ball Retainer) - d - L - L1
25SD200-125-DG-OB-25-150-60

⚠️ เลือกค่าความยาวเสา L และ ความสูงบุช L1
Choose overall guide length L and bush height L1

d	d1	L (10mm increment)	For Steel Bush (SB, OB)			For Ball Retainer Bush (NB, MB, FB)			
			D	D1	L1	DR	DR1	L1	L2
20	22	120 - 180	31	34	50	37	40	50	50
25	28	140 - 180	37	42	60	45	50	60	60
					80			80	75
32	38	180 - 240	46	54	80	55	64	80	75
					100			100	90
38	45	180 - 260	54	62	100	64	74	100	90
45	50	200 - 260	62	70	100	74	83	100	90
					120			120	110

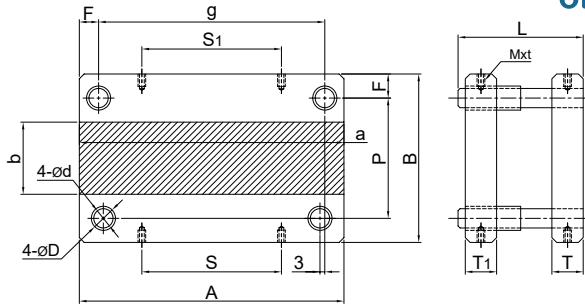

Model: 25SF

ORDER Model a - b - Guide - Bush - (Ball Retainer) - d - L - L1
EXAMPLE 25SF200-125-DG-OB-25-150-60

! ดูตารางเพิ่มเติมในหน้าต่อไป
 See addition table in the next page

a	b	Guide	Bush	(Ball Retainer) Type	d	A	B	F	g	P	T1	T	M x t	S	S1										
125	100				20	125	210	30	65	150	30	35	-	-	-										
160						160			100																
180						180			120																
200						200			140																
230						230			170																
250					250	180	25	220	35	150	35	40	M12 X 25	110	110										
300					300	230																			
350					350	280																			
400					400	330																			
450					450	380																			
125	125				20	125	230	30	65	170	30	35	-	-	-										
160						160			100																
180						180			120																
200						200			130							25	250	35	180	35	40	M12 x 25	80	60	
230						230			160																
250					250	180																			
300					300	230																			
350					350	280																			
400					400	330																			
450					450	380																			
500	160	FG (fixed)	SB (steel)	BA (Aluminum)	32	500	280	40	420	200	40	50	-	-	-										
550						550			470																
160						160			90							25	280	35	160	210	35	40	M10 x 20	135	-
180						180			110																
200						200			130																
230					230	160																			
250					250	180																			
300					300	230	32	300	40	420	220	40	50	M12 x 25	160	160									
350					350	280																			
400					400	320																			
450	450	370																							
500	500	420																							
550	550	470																							
600	600	520																							
180	180	DG (detachable)	OB (oilfree)	BS (Resin)	25	180	300	35	110	230	35	40	-	-	-										
200						200			130																
230						230			160																
250						250			180																
300						300			230							32	320	40	270	240	40	50	M10 x 20	155	-
350					350	270																			
400					400	320																			
450					450	370																			
500					500	420																			
550					550	470																			
600	600	520																							
200	200				25	200	320	35	130	250	35	40	-	-	-										
250						250			180							32	350	40	220	270	270	40	M12 x 25	140	140
300						300			220																
350						350			270																
400						400			320																
450					450	370																			
500					500	420	38	600	380	50	500	280	45	60	-	-	-								
550					550	470																			
600					600	520																			
700					700	600																			

a	b	Guide	Bush	(Ball Retainer) Type	d	A	B	F	g	P	T1	T	M x t	S	S1																
230	230	FG (fixed)	SB (steel)	BA (Aluminum)	25	230	350	35	160	280	35	40	M12 x 25	90	90																
250						180			110					110																	
300						220			140					140																	
350						270			190					190																	
400						320			240					240																	
250	250				FG (fixed)	SB (steel)	BA (Aluminum)	32	250	400	40	170		320	40	50	M12 x 25	90	90												
300									220			140						140													
350									270			190						190													
400									320			240						240													
450									370			270						270													
500		38	FG (fixed)	SB (steel)				BA (Aluminum)	38	500	450	50	400	350	45	60		M16 x 30	300	300											
550										450			330						330												
600										500			360						360												
700										600			420						420												
300										300			FG (fixed)						OB (oilfree)	BA (Aluminum)	32	300	450	40	220	370	40	50	M12 x 25	140	98
350	270	190			114																										
400	300	200			163																										
450	350	250			183																										
500	400	300			203																										
550	38	DG (detachable)			MB (movable ball)	BS (Resin)	38		550		480	50		450	380	45	60				M16 x 30	330	223								
600			500	360				242																							
700			600	420				282																							
800			700	480				321																							
350			350	DG (detachable)				MB (movable ball)	BS (Resin)					38				350				550	50	250	450	45	60	M12 x 25		150	164
400	300						200			186																					
450	350						250			209																					
500	400						300			232																					
550	450						330			254																					
600	50						DG (detachable)			MB (movable ball)	BS (Resin)	50	600	550	55	500	440	50	60	M20 x 35		360	277								
700		600			420	342																									
800		700			480	389																									
600		400			DG (detachable)	MB (movable ball)							BS (Resin)			50					600	600	55	490	490	50	60		M20 x 35	360	320
700																					590			420						372	
800	690		480	424																											
800	500		DG (detachable)	MB (movable ball)				BS (Resin)	50			800		700	55		690	590	50		60			M20 x 35				480		424	
800												800					480											529			

Die Sets

บุชเหล็ก
Steel Bush

บุชปลอกลูกปืน
Ball Retainer Bush

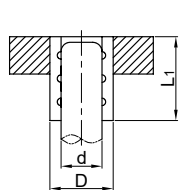

SB

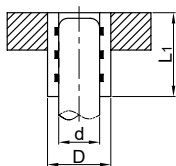

OB

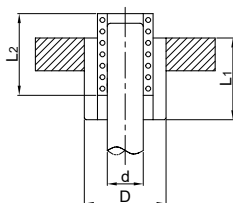

NB

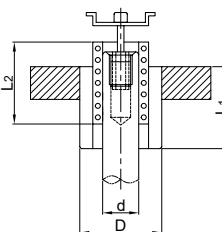

MB

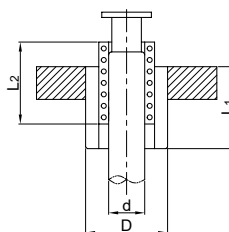

FB

ORDER EXAMPLE Model a - b - Guide - Bush - (Ball Retainer) - d - L - L1
25SF200-125-DG-OB-25-150-60

! เลือกค่าความยาวเสา L และ ความสูงบุช L1
Choose overall guide length L and bush height L1

d	L (10mm increment)	For Steel Bush (SB, OB)		For Ball Retainer Bush (NB, MB, FB)		
		D	L1	D	L1	L2
20	100 - 180	31	50	37	50	50
25	120 - 180	37	60	45	60	60
			80		80	75
32	160 - 240	46	80	55	80	75
			100		100	90
38	180 - 260	54	80	64	80	75
			100		100	90
50	200 - 260	70	100	83	100	90
			120		120	110

ไม่มีสตั๊อปเปอร์
No Stopper

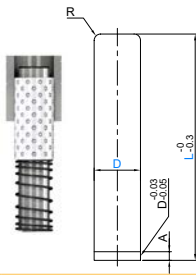

ฝาครอบเลื่อนได้
Movable Stopper

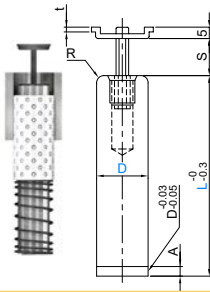

ฝาครอบตายตัว
Fixed Stopper

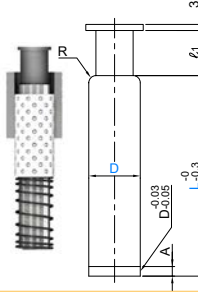

Ball Retainer Material	Model		
Aluminum	25PB	25PM	25PK
Resin	25GB	25GM	25GK

D	A	R	t
20	4	2.0	1.6
22		+0.020	
25		+0.015	
28	5	3.5	2.0
32		+0.025	
38	6	4.0	2.0
45		+0.025	
50	7	5.0	2.0
60		+0.035	

Die Sets

บุช
Bush

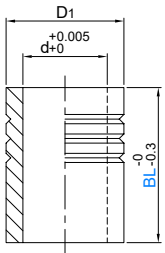

! ติดตั้งบุชด้วยกาว ห้ามสวมอัด
Install bush with glue only.
Do not use press-fit method.

d	D1	
26	37	0.000 -0.007
28	40	
31	45	
36	50	0.000 -0.008
40	55	
48	64	
55	74	0.000 -0.010
60	83	
70	95	

ปลอกลูกปืน
Ball Retainer

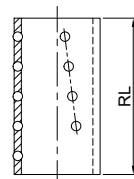

RL	S	L1
50	0 - 19	15
60	0 - 23	20
75	0 - 30	25
90	0 - 37	30
110	0 - 47	35

! ดูวิธีคำนวณค่า FL ได้จากหน้า 29
See FL calculation guide on page 29

สปริง
Spring

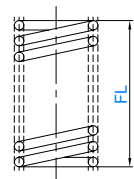

ORDER EXAMPLE Model D - L - BL - FL
25PB25-120-60-100

i เลือกโมเดลตามรูปแบบสตั๊อปเปอร์และวัสดุปลอกลูกปืน
Choose model from stopper type and Ball Retainers material

D	L										BL	FL 10mm increments	RL					
20	100	110	120	130	140	150	160	170	180		50	40 - 140	50					
22			120	130	140	150	160	170	180		50	40 - 140	50					
											60		60					
25			120	130	140	150	160	170	180		60	40 - 150	60					
											80		75					
28					140	150	160	170	180	190	200		60	50 - 150	60			
													80		75			
32							160	170	180	190	200	220	240		80	70 - 190	75	
															100		90	
38									180	190	200	220	240	260		80	80 - 190	75
																100		90
45									180	190	200	220	240	260		100	80 - 190	90
																120		110
50											200	220	240	260		100	80 - 190	90
																120		110
60											200	220	240	260		100	80 - 190	90
																120		110

Removable Ball Guide Post for Die Set - โกดโพสลูกปืนสำหรับไดเซต แบบถอดได้



ไม่มีสตั๊ปเปอร์
No Stopper

ฝาครอบเลื่อนได้
Movable Stopper

ฝาครอบตายตัว
Fixed Stopper

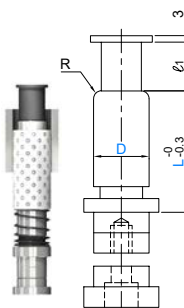
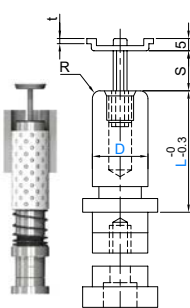
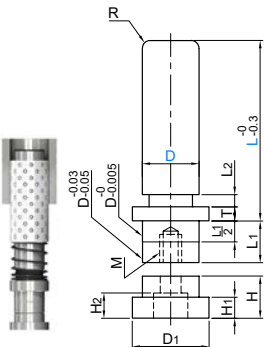

D	D1	L1	L2	H	H1	H2
20		28	15	10	14	7
22	+0.020 +0.015	30	16		16	8
25		35	18	12	18	10
28	+0.025 +0.020	36	20		16	8
32		40	23	15	20	12.5
38	+0.030 +0.025	49	27		18	10
45		55	32	20	12	14.5
50	+0.035 +0.030	62	35		20	12
60		72	42			

Ball Retainer Material	Model		
Aluminum	25RB	25RM	25RK
Resin	25QB	25QM	25QK

D	T	t	M	R	Bolt
20	5	8	1.6	2.0	24CB8x25
22	+0.020 +0.015			3.0	
25		10	10x22	3.5	24CB10x30
28	+0.025 +0.020			4.0	
32		12	12x27	4.0	24CB12x35
38	+0.030 +0.025			4.5	
45		15	14x31	4.5	24CB14x40
50	+0.035 +0.030				
60					

บุช
Bush

⚠️ ติดตั้งบุชด้วยกาว ห้ามสวมอัด
Install bush with glue only.
Do not use press-fit method.

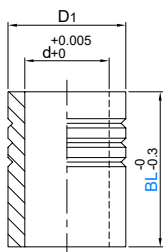

d	D1	
26	37	0.000 -0.007
28	40	
31	45	
36	50	0.000 -0.008
40	55	
48	64	
55	74	0.000 -0.010
60	83	
70	95	

ปลอกลูกปืน
Ball Retainer

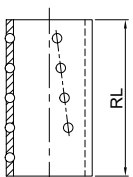

RL	S	L1
50	0 - 19	15
60	0 - 23	20
75	0 - 30	25
90	0 - 37	30
110	0 - 47	35

⚠️ ดูวิธีคำนวณค่า FL ได้จากหน้า 29
See FL calculation guide on page 29

สปริง
Spring

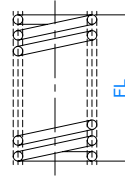

ORDER EXAMPLE

Model D - L - BL - FL
25RB25-100-60-100

ⓘ เลือกโมเดลตามรูปแบบสตั๊ปเปอร์และวัสดุปลอกลูกปืน
Choose model from stopper type and Ball Retainers material

D	L						BL	FL 10mm increments	RL
20	80	90	100	110	120		50	40 - 140	50
22	+0.020 +0.015	80	90	100	110	120	50	40 - 140	50
							60		60
25		80	90	100	110	120	60	40 - 150	60
							80		75
28				100	110	120	60	50 - 150	60
							80		75
32					120	130	80	70 - 190	75
							100		90
38						140	80	80 - 190	75
							100		90
45						140	100	80 - 190	90
							120		110
50							100	80 - 190	90
							120		110
60							100	80 - 190	90
							120		110

บุชร่องน้ำมัน
Oil Groove Bush
Model: 25PD

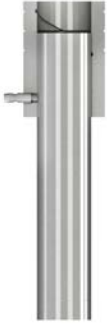

บุชออยฟรี
Oil Free™ Bush
Model: 25PZ

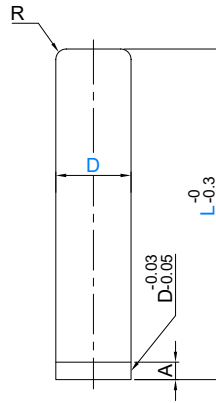
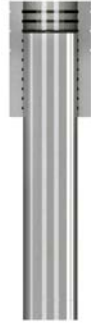

ไกด์ | Guide

D	A	R
20	4	2.0
22		3.0
25	5	3.5
28		4.0
32	6	4.5
38		5.0
45	7	6.0
50		7.5
60		

บุช | Bush

L1	d	D1
10	20	31
	22	34
	25	37
	28	42
15	32	46
	38	54
	45	62
	50	70
	60	80

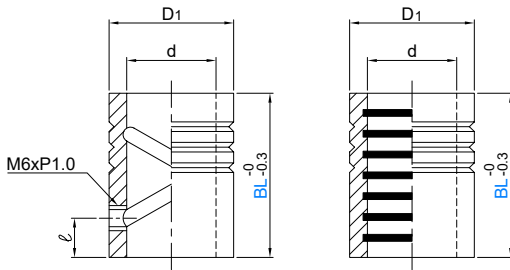

ORDER EXAMPLE Model D - L - BL
25PD25-120-60

! ติดตั้งบุชด้วยกาว ห้ามสวมอัด
Install bush with glue only. Do not use press-fit method.

Model	D		L												BL						
25PD 25PZ	20		100	110	120	130	140	150	160	170	180								50		
	22	+0.020 +0.015			120	130	140	150	160	170	180								50		
																		60			
	25				120	130	140	150	160	170	180								60		
																			80		
	28	+0.025 +0.020					140	150	160	170	180	190	200						60		
																			80		
	32									160	170	180	190	200	220	240				80	
																		100			
38	+0.030 +0.025										180	190	200	220	240	260				80	
																		100			
45											180	190	200	220	240	260				100	
																		120			
50	+0.035 +0.030												200	220	240	260				100	
																		120			
60														200	220	240	260				100
																		120			

Removable Guide Post for Die Set - โกลด์โพสสำหรับไดเซต แบบถอดได้



บุชร่องน้ำมัน
Oil Groove Bush
Model: 25RD

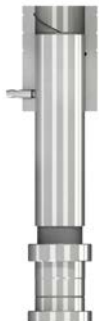

บุชขอยฟรี
Oil Free™ Bush
Model: 25RZ

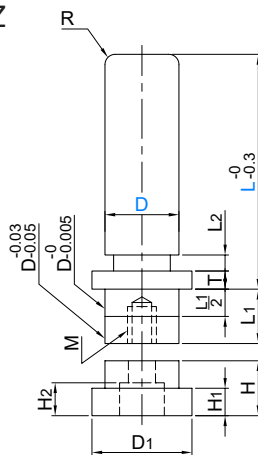

โกลด์ | Guide

D	D1	L1	L2	H	H1	H2
20		28	15	10	14	7
22	+0.020 +0.015	30	16			
25		35	18			
28	+0.025	36	20	12	16	8
32	+0.020	40	23			
38	+0.030	49	27	15	18	10
45	+0.025	55	32			
50	+0.035	62	35	20	12	14.5
60	+0.030	72	42			

D	T	t	M	R	Bolt
20	5	1.6	8x18	2.0	24CB8x25
22	8			3.0	
25	10		10x22	3.5	24CB10x30
28	12	2.0	12x27	4.0	24CB12x35
32					
38					
45					
50					
60					

บุช | Bush

L1	d	D1
10	20	31
	22	34
	25	37
	28	42
15	32	46
	38	54
	45	62
	50	70
60	80	

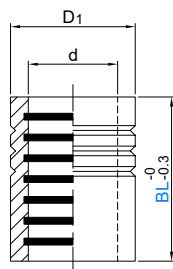
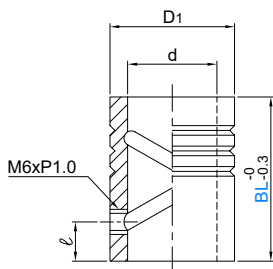

ORDER EXAMPLE

Model D - L - BL
25RD25-120-60



ติดตั้งบุชด้วยกาว ห้ามสวมอัด
Install bush with glue only. Do not use press-fit method.

Model	D		L												BL						
25RD 25RZ	20	+0.020 +0.015	80	90	100	110	120							50							
	22		80	90	100	110	120							50							
	25		80	90	100	110	120	130							60						
	28	+0.025 +0.020				100	110	120	130	140	150	160					60				
	32								120	130	140	150	160					80			
	38	+0.030 +0.025										140	150	160	170	180			80		
	45											140	150	160	170	180			100		
	50														160	170	180	200			100
	60	+0.035 +0.030													160	170	180	200			100